

Installation Guide

This procedure is designed as an installation aid. Skilled tradespeople that are familiar with general construction and electrical installation techniques should perform the installation. Licensed electricians should provide electrical installation connections. Installations and connections should be done in accordance with all national and local codes and permits. In no way is this document intended to construe warranty or fitness of use of the products described, nor is it intended to provide safety instruction for those installing the product.

Check whether it concerns an AC(Alternating Current)based or DC(Direct Current) based system

Caution:
Switch Off the Power Supply

New Installation

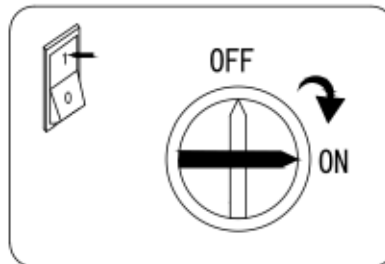
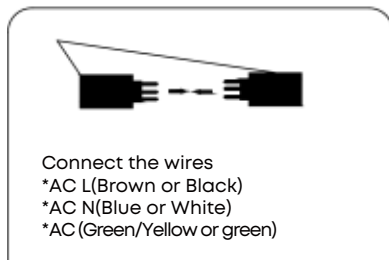
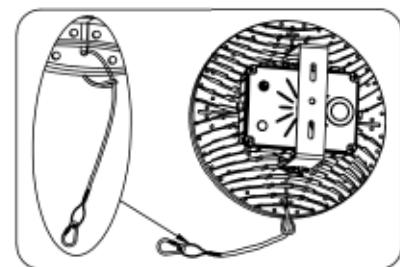
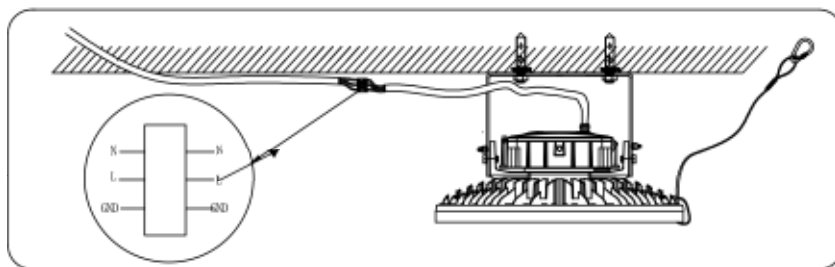
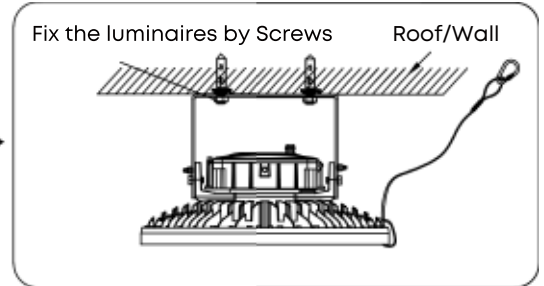
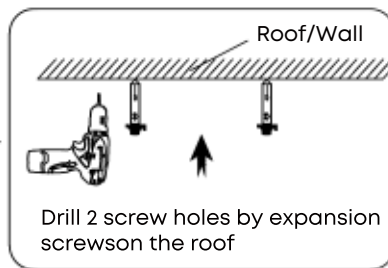
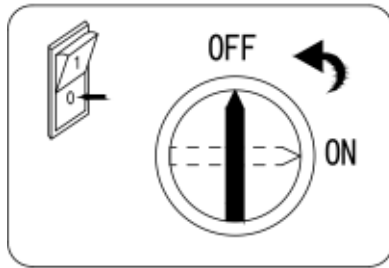

Caution:
- Turn power Off During Installation.
- Do Not Connect Or Disconnect Under Load
- Caution Risk of Fire

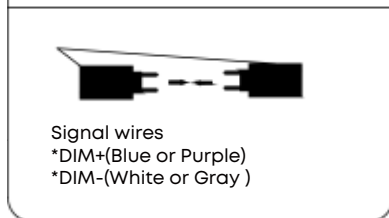

Bracket dimension

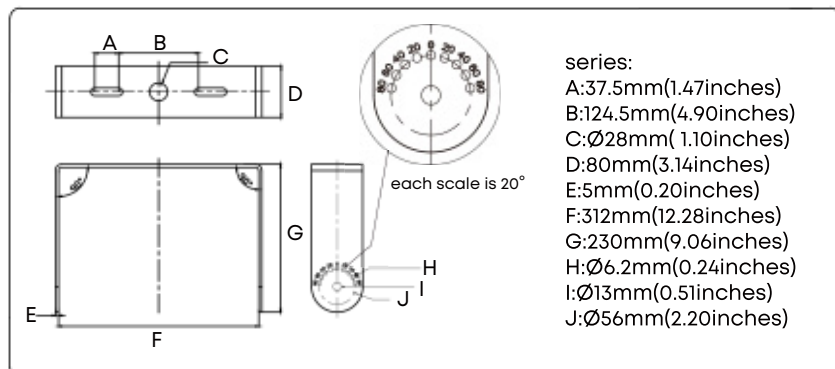

The product (LED lighting equipment, electrical , electronic equipment) should not be placed in municipal waste. Check local regulations for disposal of electronic products.

& Features and specifications are subject to change without notice.

& The product color may be different with actual due to discrepancy of camera or screen settings.

WARNING

Before proceeding with installation or service maintenance of this product:

- Disconnect power to reduce electrical shock risk.
- Review the entire Installation Guide.
- Inspect this properly packaged product for any damage that may have occurred during transit.
- Verify product application complies with manufacturer design recommendations.
- Verify the availability of necessary tools and incidental material.
- Verify applicable code requirements. Field assembly and installation are subject to acceptance by local inspection authority.
- Appropriate safety equipment to be determined by end user, per applicable safety standards and precautions.